



Smart Toilets

Intelligent toilet that combines the highest design standards

info@utctradingllc.com





AFTER-SALE WORRY FREE

- 7 The whole day through
- Feedback quickly
- Technology professional
- After-sale tracking



T31
Exclusive patented product

No water
pressure limit
More intelligent, more considerate

All product sizes and colors prevail in kind, subject to change without notice.

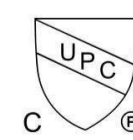

Fragrance Is In Everywhere

Adapt The On-Mounted Incense System ,
Add Your Favorite Essential Oil To Purify The Bathroom



Intelligent Control Board



scan and watch



ZL 202230122185.9

Patented product
no infringement allowed



Basic Version :

- 01.Essential Oil Aromatherapy System
- 02.No Water Pressure Limited
- 03.Intelligent Control Board

High Version :

- 01.Essential Oil Aromatherapy System
- 02.No Water Pressure Limited
- 03.Intelligent Control Board
- 04.UV sterilization
- 05.Auto Open Cover /Off Seat
- 06.Dual Flip Modes

Top Version :

- 01.Essential Oil Aromatherapy System
- 02.No Water Pressure Limited
- 03.Intelligent Control Board
- 04.UV sterilization
- 05.Auto Open Cover /Off Seat
- 06.Dual Flip Modes
- 07.Baby Seating Flip

G5

Product Name:Smart Toilet
Dimension:700x400x465mm
Rough in:300/400mm
Material: Ceramic/ABS Seat Cover
Heating:Instant

- | | | |
|---------------------------|--------------------------------|-----------------------------------|
| 01.Female Washing | 11.Warm Air Drying | 21.Double Filtration |
| 02.Hip Cleaning | 12.Wind Temperature Adjust | 22.A Key Knob |
| 03.Mobile Washing | 13.Water Temperature Adjust | 23.Smart Cleaning Glaze |
| 04.Message Washing | 14.Water Pressure Adjust | 24.Flame Retardant Material |
| 05.Self-cleaning Nozzle | 15.Auto Flushing When Leaving | 25.Baby Washing Mode |
| 06.A Key To Stop | 16.Flush During Power Failure | 26.Active Moving Atmosphere Light |
| 07.Nozzle Adjustment | 17.Mute Slow Down | 27.LED Screen Showing |
| 08.Heated Water Instantly | 18.Night Light | 28.12V Safety Voltage |
| 09.Seat Induction | 19.Leakage Protection | 29.Smart Remote |
| 10.Seat Heating | 20.Energy Province Electricity | |

Rotating foam shield

New design Double 180 degree cycle

Rich foam layer lock the water surface
 avoid the spanishing
 avoid the dirt stick on the toilet surface



180 degree rotate



anti-odor

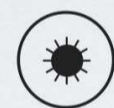

anti-infection



anti splashing



anti- stick

- 01.Reasonable design , higher than the washing surface
- 02.Bubble flushing and flushing is seperately ,not be come back flow
- 03.Spin foam cover the whole inner wall
- 04.Easy cleaning of the bubble hole



Intelligent Control Board



scan and watch



ZL 202221300692.8

Patented product
no infringement allowed

G7pro

G7 Silver

G7 Black



Basic Version :

01. Phone app connected
02. Aromatherapy system
03. No water presure limited
04. Intelligent control board

High Version :

01. Phone app connected
02. Aromatherapy system
03. No water presure limited
04. Intelligent control board
05. Rotating bubble
06. Off seat sterilization
07. Auto open cover
08. Two modes switch

Top Version :

01. Phone app connected
02. Aromatherapy system
03. No water presure limited
04. Intelligent control board
05. Rotating bubble
06. Off seat sterilization
07. Auto open cover
08. Two modes switch
09. Voice control function
10. Baby seating

G7/G7pro

Product Name:Smart Toilet
 Dimension:700x400x465mm
 Rough in:300/400mm
 Material: Ceramic/ABS Seat Cover
 Heating:Instant

- | | | |
|---------------------------|--------------------------------|---|
| 01.Female Washing | 11.Warm Air Drying | 21.Double Filtration |
| 02.Hip Cleaning | 12.Wind Temperature Adjust | 22.One Key Knob |
| 03.Mobile Washing | 13.Water Temperature Adjust | 23.Smart cleaning glaze |
| 04.Message Washing | 14.Water Pressure Adjust | 24.Flame retardant material |
| 05.Self-cleaning Nozzle | 15.Auto Flushing When Leaving | 25.Baby washing modes |
| 06.A Key To Stop | 16.Flush During Power Failure | 26.Silver ion antibacterial toilet seat |
| 07.Nozzle Adjustment | 17.Mute Slow Down | 27.LED screen |
| 08.Heated Water Instantly | 18.Night Light | 28.12V safety voltage |
| 09.Seat Induction | 19.Leakage Protection | 29.Smart remote |
| 10.Seat Heating | 20.Energy Province Electricity | |

Multiple Types Security Protection

Pay attention to each security details ,protect your live

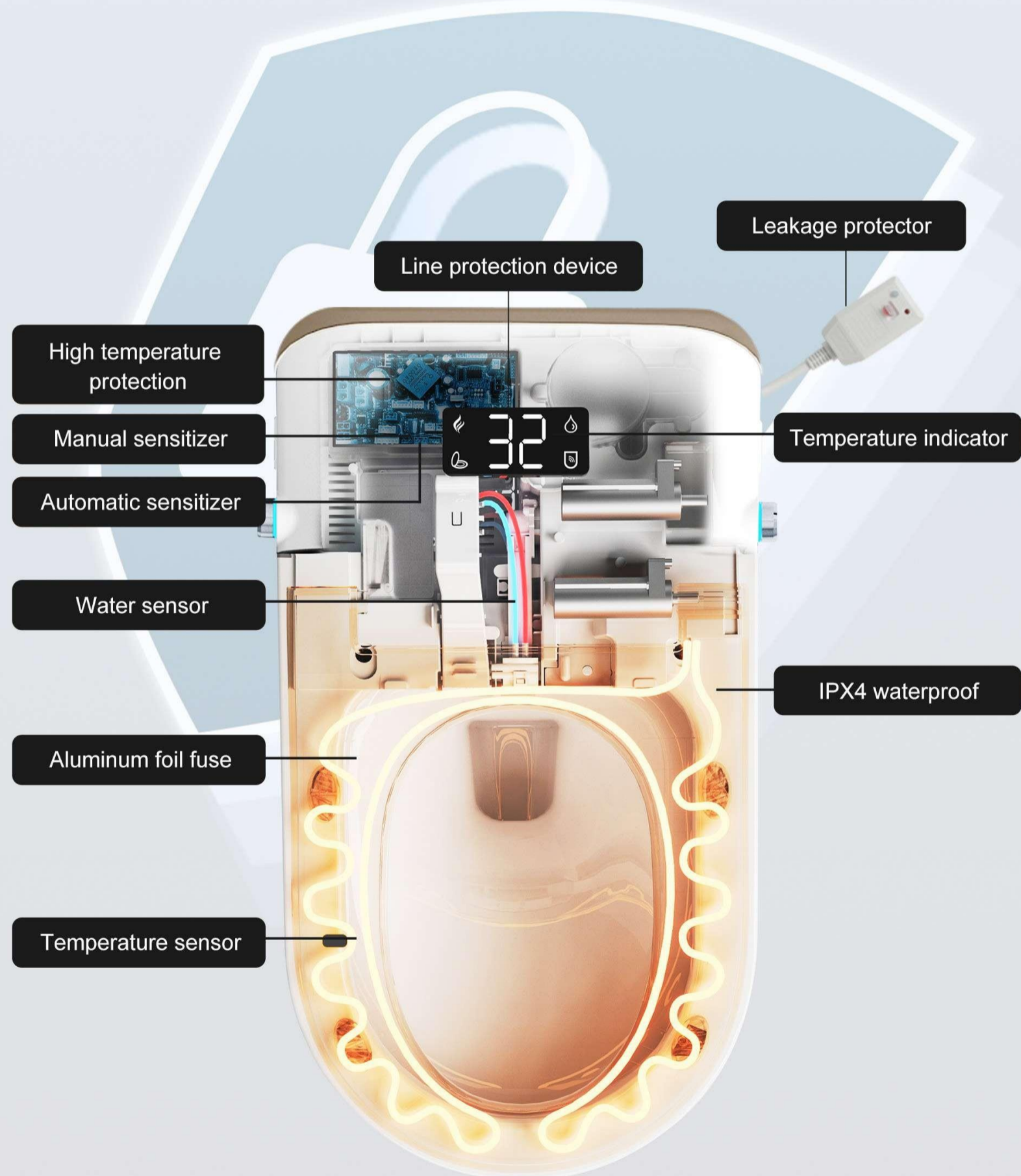

Intelligent control board



Smart Remote



ZL 202230586702. 8
Patented Product
Infringement must be prosecuted



Basic Version :

- 01.Phone app connected
- 02.Double aromatherapy system
- 03.Intelligent control board
- 04.Smart double side knob
- 05.Foot touch for flushing

High Version :

- 01.Phone app connected
- 02.Double aromatherapy system
- 03.Intelligent control board
- 04.Smart double side knob
- 05.Off seat sterilization
- 06.Auto open cover
- 07.Foot touch for open cover
- 08.Two modes switch

Top Version :

- 01.Phone app connected
- 02.Double aromatherapy system
- 03.Intelligent control board
- 04.Smart double side knob
- 05.Off seat sterilization
- 06.Two modes open cover
- 07.Voice control function
- 08.Baby seating
- 09.Built-in bubble liquid
- 10.Rotating bubble

U2

Product Name:Smart Toilet
Dimension:700x400x465mm
Rough in:300/400mm
Material: Ceramic/ABS Seat Cover
Heating:Instant

- | | | |
|---------------------------|--------------------------------|---|
| 01.Female Washing | 12.Wind Temperature Adjust | 23.Smart cleaning glaze |
| 02.Hip Cleaning | 13.Water Temperature Adjust | 24.Flame retardant material |
| 03.Mobile Washing | 14.Water Pressure Adjust | 25.Baby washing modes |
| 04.Message Washing | 15.Auto Flushing When Leaving | 26.Moving light |
| 05.Self-cleaning Nozzle | 16.Flush During Power Failure | 27.Foot touch for flushing |
| 06.A Key To Stop | 17.Mute Slow Down | 28.Silver ion antibacterial toilet seat |
| 07.Nozzle Adjustment | 18.Night Light | 29.LED screen |
| 08.Heated Water Instantly | 19.Leakage Protection | 30.12V safety voltage |
| 09.Seat Induction | 20.Energy Province Electricity | 31.Smart remote |
| 10.Seat Heating | 21.Double Filtration | 32.No water pressure limited |
| 11.Warm Air Drying | 22.One Key Knob | |

Phone can also as the remote

Easy control all functions at anytime anywhere



INTELLIGENT CONTROL



Intelligent control board



Smart Remote



ZL 202230696202. X
Patented Product
Infringement must be prosecuted



Basic Version :

- 01. Phone app connected
- 02. Intelligent control board
- 03. Smart double side knob
- 04. Foot touch for flushing

Top Version :

- 01. Phone app connected
- 02. Intelligent control board
- 03. Smart double side knob
- 04. Off seat sterilization
- 05. Two modes open cover
- 06. Auto open cover
- 07. Voice control function
- 08. Baby seating
- 09. Built-in bubble liquid
- 10. Rotating bubble

High Version :

- 01. Phone app connected
- 02. Intelligent control board
- 03. Smart double side knob
- 04. Off seat sterilization
- 05. Auto open cover
- 06. Foot touch for open cover
- 07. Two modes switch
- 08. Foot touch for flushing

K1

Product Name: Smart Toilet
Dimension: 700x400x465mm
Rough in: 300/400mm
Material: Ceramic/ABS Seat Cover
Heating: Instant

- | | | |
|----------------------------|---------------------------------|--|
| 01. Female Washing | 12. Wind Temperature Adjust | 23. Smart cleaning glaze |
| 02. Hip Cleaning | 13. Water Temperature Adjust | 24. Flame retardant material |
| 03. Mobile Washing | 14. Water Pressure Adjust | 25. Baby washing modes |
| 04. Message Washing | 15. Auto Flushing When Leaving | 26. Moving light |
| 05. Self-cleaning Nozzle | 16. Flush During Power Failure | 27. Foot touch for flushing |
| 06. A Key To Stop | 17. Mute Slow Down | 28. Silver ion antibacterial toilet seat |
| 07. Nozzle Adjustment | 18. Night Light | 29. LED screen |
| 08. Heated Water Instantly | 19. Leakage Protection | 30. 12V safety voltage |
| 09. Seat Induction | 20. Energy Province Electricity | 31. Smart remote |
| 10. Seat Heating | 21. Double Filtration | 32. No water pressure limited |
| 11. Warm Air Drying | 22. One Key Knob | |



scan and watch



ZL: 202130768984.9

PATENTED PRODUCT NO
INFRINGEMENT ALLOWED

W4

W4

W4

W1

Basic Version :

- 01.Manual open cover
- 02.Foot sensing flush

Advanced Version :

- 01.Auto /Foot sensing open cover
- 02.Foot sensing open flip

**HEALTH AND TECHNOLOGY
GO TOGETHER**

W1/W4

Product Name:Smart Toilet
Dimension:680x400x470mm
Rough in:300/400mm
Material: Ceramic/ABS Seat Cover
Heating:Instant

- | | | |
|---------------------------|------------------------------------|-----------------------------|
| 01.Female cleaning | 11.Drying | 21.Leakage protection |
| 02.Hip cleaning | 12.Wind temperature regulation | 22.Energy saving |
| 03.Mobile cleaning | 13.Water temperature regulation | 23.Double filtration |
| 04.Massage cleaning | 14.Water-pressure adjust | 24.12V safety voltage |
| 05.Self-cleaning nozzle | 15.Automatic flush | 25.Anti-fouling glaze |
| 06.A key to stop | 16.Flush during power failure | 26.Flame retardant material |
| 07.Spray regulation | 17.Flushing by identify male urine | 27.Remote control |
| 08.Heated water instantly | 18.Foot sensor flush | |
| 09.Seat induction | 19.Mute slow down | |
| 10.Seat heating | 20.Night light | |

THE BEAUTY OF DANGLING

New enjoy of technology



save space /easy clean /stable flush



Has passed the test of EN1717



- 58cm mini toilet
- Automatic open cover
- Foot sensor open seat
- Flush by foot sensor
- Side knob
- LED digital screen



scan and watch



ZL:2020301585867
PATENTED PRODUCT
NO INFRINGEMENT ALLOWED



T31

Product Name:Wall mounted smart toilet
Dimension:580x380x350mm
Drainage way:P-trap
Material: Ceramic/ABS Seat Cover
Heating:Instant

- | | | |
|---------------------------|---------------------------------|-----------------------------|
| 01.Female cleaning | 10.Seat heating | 19.Leakage protection |
| 02.Hip cleaning | 11.Drying | 20.Energy saving |
| 03.Mobile cleaning | 12.Wind temperature regulation | 21.Double filtration |
| 04.Massage cleaning | 13.Water temperature regulation | 22.12V safety voltage |
| 05.Self-cleaning nozzle | 14.Water-pressure adjust | 23.Anti-fouling glaze |
| 06.A key to stop | 15.Automatic flush | 24.Flame retardant material |
| 07.Spray regulation | 16.Flush during power failure | 25.Side knob |
| 08.Heated water instantly | 17.Mute slow down | 26.Remote control |
| 09.Seat induction | 18.Night light | |

Basic vision:Open cover by manual Flush by foot sensor
Advanced vision:Double flip modes Open seat by foot induction Close cover automatically
Flushing by identify male urine

WALL MOUNTED SAMRT TOILET

Save room / clean easy / flush powerful

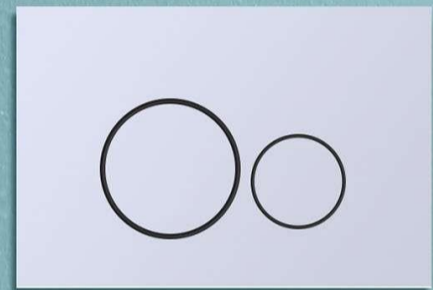

Two modes of flushing buttons



English remote control

one side knob to operate



Has passed the test of EN1717



- 58cm mini toilet
- Automatic open cover
- Foot sensor open seat
- Flush by foot sensor
- Side knob
- LED digital screen



scan and watch

ZL:2020301585867
PATENTED PRODUCT
NO INFRINGEMENT ALLOWED



white



black

T3

Product Name:Wall mounted smart toilet
Dimension:580x380x350mm
Drainage way:P-trap
Material: Ceramic/ABS Seat Cover
Heating:Instant

- | | | |
|---------------------------|---------------------------------|-----------------------------|
| 01.Female cleaning | 10.Seat heating | 19.Leakage protection |
| 02.Hip cleaning | 11.Drying | 20.Energy saving |
| 03.Mobile cleaning | 12.Wind temperature regulation | 21.Double filtration |
| 04.Massage cleaning | 13.Water temperature regulation | 22.12V safety voltage |
| 05.Self-cleaning nozzle | 14.Water-pressure adjust | 23.Anti-fouling glaze |
| 06.A key to stop | 15.Automatic flush | 24.Flame retardant material |
| 07.Spray regulation | 16.Flush during power failure | 25.Side knob |
| 08.Heated water instantly | 17.Mute slow down | 26.Remote control |
| 09.Seat induction | 18.Night light | |

Basic vision:Open cover by manual Flush by foot sensor
Advanced vision:Double flip modes Open seat by foot induction Close cover automatically
Flushing by identify male urine

Mini Size

58cm Length
Save more space



58cm



Mini smart toilet Normal smart toilet

Has passed the test of EN1717



ZL:2020301585867
PATENTED PRODUCT
NO INFRINGEMENT ALLOWED

- 58cm mini toilet
- Automatic open cover
- Foot sensor open seat
- Flush by foot sensor
- Side knob
- LED digital screen



scan and watch

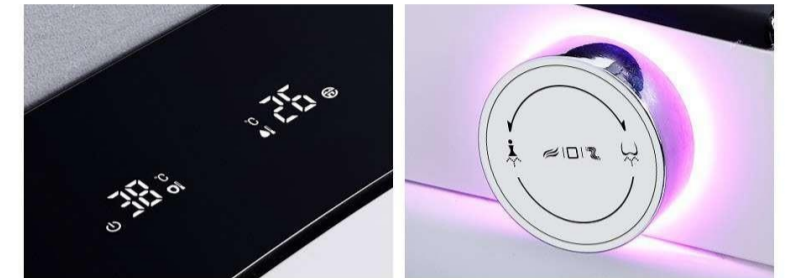

T4 (P-trap) T4 (S-trap)

Product Name:Mini smart toilet
Dimension:580x380x450mm
Rough in:300/400mm
Material: Ceramic/ABS Seat Cover
Heating:Instant

- | | | |
|---------------------------|---------------------------------|-----------------------------|
| 01.Female cleaning | 10.Seat heating | 19.Night light |
| 02.Hip cleaning | 11.Drying | 20.Leakage protection |
| 03.Mobile cleaning | 12.Wind temperature regulation | 21.Energy saving |
| 04.Massage cleaning | 13.Water temperature regulation | 22.Double filtration |
| 05.Self-cleaning nozzle | 14.Water-pressure adjust | 23.12V safety voltage |
| 06.A key to stop | 15.Glaze washing | 24.Anti-fouling glaze |
| 07.Spray regulation | 16.Automatic flush | 25.Flame retardant material |
| 08.Heated water instantly | 17.Flush during power failure | 26.Remote control |
| 09.Seat induction | 18.Mute slow down | |

Basic vision:Open cover by manual Flush by foot sensor
Advanced vision:Double flip modes Open seat by foot induction Close cover automatically
Flushing by identify male urine



ZL:2020301585867
PATENTED PRODUCT
NO INFRINGEMENT ALLOWED

- 58cm mini toilet
- Automatic open cover
- Foot sensor open seat
- Flush by foot sensor
- Side knob
- LED digital screen



scan and watch



T41 (P-trap) T41 (S-trap)

Product Name:Mini smart toilet
Dimension:580x380x450mm
Rough in:300/400mm
Material: Ceramic/ABS Seat Cover
Heating:Instant

- | | | |
|---------------------------|---------------------------------|-----------------------------|
| 01.Female cleaning | 10.Seat heating | 19.Night light |
| 02.Hip cleaning | 11.Drying | 20.Leakage protection |
| 03.Mobile cleaning | 12.Wind temperature regulation | 21.Energy saving |
| 04.Massage cleaning | 13.Water temperature regulation | 22.Double filtration |
| 05.Self-cleaning nozzle | 14.Water-pressure adjust | 23.12V safety voltage |
| 06.A key to stop | 15.Glaze washing | 24.Anti-fouling glaze |
| 07.Spray regulation | 16.Automatic flush | 25.Flame retardant material |
| 08.Heated water instantly | 17.Flush during power failure | 26.Remote control |
| 09.Seat induction | 18.Mute slow down | |

Basic vision:Open cover by manual Flush by foot sensor
Advanced vision:Double flip modes Open seat by foot induction Close cover automatically
Flushing by identify male urine

ENJOY INTELLIGENT

No afraid of low water pressure



- Automatic open cover
- Foot sensor open seat
- Flush by foot sensor
- Side knob
- LED digital screen



scan and watch



white

T5-P

Product Name:Wall mounted smart toilet
 Dimension:730x370x840mm
 Drainage way:P-trap
 Material: Ceramic/ABS Seat Cover
 Heating:Instant

- | | | |
|---------------------------|---------------------------------|-----------------------------|
| 01.Female cleaning | 10.Seat heating | 19.Leakage protection |
| 02.Hip cleaning | 11.Drying | 20.Energy saving |
| 03.Mobile cleaning | 12.Wind temperature regulation | 21.Double filtration |
| 04.Massage cleaning | 13.Water temperature regulation | 22.12V safety voltage |
| 05.Self-cleaning nozzle | 14.Water-pressure adjust | 23.Anti-fouling glaze |
| 06.A key to stop | 15.Automatic flush | 24.Flame retardant material |
| 07.Spray regulation | 16.Flush during power failure | 25.Side knob |
| 08.Heated water instantly | 17.Mute slow down | 26.Remote control |
| 09.Seat induction | 18.Night light | |

Basic vision:Open cover by manual Flush by foot sensor
 Advanced vision:Double flip modes Open seat by foot induction Close cover automatically
 Flushing by identify male urine



- Automatic open cover
- Foot sensor open seat
- Flush by foot sensor
- Side knob
- LED digital screen



scan and watch



T51-P

Product Name:Wall mounted smart toilet
 Dimension:730x370x840mm
 Drainage way:P-trap
 Material: Ceramic/ABS Seat Cover
 Heating:Instant

- | | | |
|---------------------------|---------------------------------|-----------------------------|
| 01.Female cleaning | 10.Seat heating | 19.Leakage protection |
| 02.Hip cleaning | 11.Drying | 20.Energy saving |
| 03.Mobile cleaning | 12.Wind temperature regulation | 21.Double filtration |
| 04.Massage cleaning | 13.Water temperature regulation | 22.12V safety voltage |
| 05.Self-cleaning nozzle | 14.Water-pressure adjust | 23.Anti-fouling glaze |
| 06.A key to stop | 15.Automatic flush | 24.Flame retardant material |
| 07.Spray regulation | 16.Flush during power failure | 25.Side knob |
| 08.Heated water instantly | 17.Mute slow down | 26.Remote control |
| 09.Seat induction | 18.Night light | |

Basic vision:Open cover by manual Flush by foot sensor
 Advanced vision:Double flip modes Open seat by foot induction Close cover automatically
 Flushing by identify male urine

Fashionable car streamlined shape design to be one whole , more easier for cleaning

One side knob control all the toilet functions , make it more elegance and simply
Car streamlined design cover combine with the ceramic bidet to be one whole without any gap, more easier for cleaning



- No water pressure limit
- Automatic flip
- AI voice remind
- LED digital screen
- Side knob



ZL:202120308305.4
PATENTED PRODUCT
NO INFRINGEMENT ALLOWED



gold



sliver



i12

Product Name: Smart Toilet
Dimension: 680x400x560mm
Rough in: 300/400mm
Material: Ceramic/ABS Seat Cover
Heating: Instant

- | | | |
|----------------------------|-------------------------------------|------------------------------|
| 01. Female cleaning | 11. Drying | 21. Energy saving |
| 02. Hip cleaning | 12. Wind temperature regulation | 22. Double filtration |
| 03. Mobile cleaning | 13. Water temperature regulation | 23. 12V safety voltage |
| 04. Massage cleaning | 14. Water-pressure adjust | 24. Anti-fouling glaze |
| 05. Self-cleaning nozzle | 15. Automatic flush | 25. Flame retardant material |
| 06. A key to stop | 16. Flush during power failure | 26. Remote control |
| 07. Spray regulation | 17. Flushing by identify male urine | 27. Double flip modes |
| 08. Heated water instantly | 18. Mute slow down | |
| 09. Seat induction | 19. Night light | |
| 10. Seat heating | 20. Leakage protection | |

WHY?

WHY CHOOSE 0 WATER PRESSURE!

No pulse valve failure

Don't worry about low water pressure

Avoid noise caused by high water pressure

Sunken Water Tank with Elegant appearance



Sunken Water Tank without water pressure limit

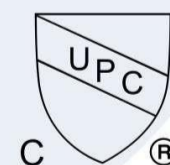

- No water pressure limit
- Open cover by radar automatic
- AI Voice broadcast
- LED indicating screen
- Knob operation key
- Dual user mode



scan and watch



Control by APP



luxury gold color



crystal green



black



Space silver



white



light blue



olive green

i11 Foot flush can be customized

Product Name: Smart Toilet
 Dimension: 680x400x560mm
 Rough in: 300/400mm
 Material: Ceramic/ABS Seat Cover
 Heating: Instant

- | | | |
|----------------------------|----------------------------------|-------------------------------------|
| 01. Female cleaning | 11. Drying from heater | 21. Double filtration |
| 02. Hip cleaning | 12. Wind temperature regulation | 22. Smart cleaning glaze |
| 03. Mobile cleaning | 13. Water temperature regulation | 23. Flame retardant material |
| 04. Massage cleaning | 14. Water-pressure adjust | 24. Power Memory |
| 05. Self-cleaning nozzle | 15. Automatic flush | 25. 12V safety voltage |
| 06. A key to stop | 16. Flush during power failure | 26. Remote control |
| 07. Spray regulation | 17. Mute slow down | 27. ACC Fault voice broadcast |
| 08. Heated water instantly | 18. Night light | 28. Flushing by identify male urine |
| 09. Seat induction | 19. Leakage protection | 29. Double mode switch |
| 10. Seat heating | 20. Energy province electricity | |

SUNKEN WATER TANK

No water pressure limit

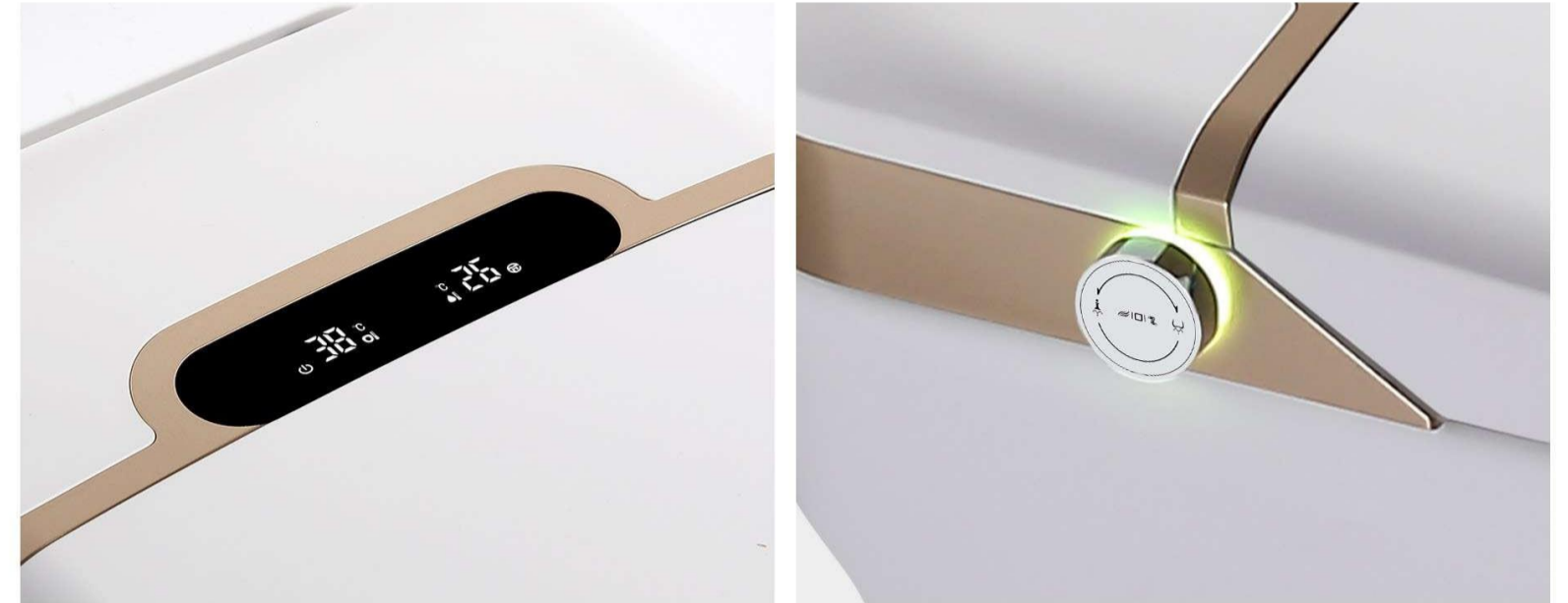

- Automatic open cover
- Foot sensor open seat
- LED digital screen
- Side knob



scan and watch



ZL:2020307424612

PATENTED PRODUCT
NO INFRINGEMENT ALLOWED

V9 (P-trap) V9 (S-trap)

Product Name: Smart Toilet
Dimension: 680x400x470mm
Rough in: 300/400mm
Material: Ceramic/ABS Seat Cover
Heating: Instant

- | | | |
|----------------------------|-------------------------------------|------------------------------|
| 01. Female cleaning | 11. Drying | 21. Leakage protection |
| 02. Hip cleaning | 12. Wind temperature regulation | 22. Energy saving |
| 03. Mobile cleaning | 13. Water temperature regulation | 23. Double filtration |
| 04. Massage cleaning | 14. Water-pressure adjust | 24. 12V safety voltage |
| 05. Self-cleaning nozzle | 15. Automatic flush | 25. Anti-fouling glaze |
| 06. A key to stop | 16. Flush during power failure | 26. Flame retardant material |
| 07. Spray regulation | 17. Flushing by identify male urine | 27. Remote control |
| 08. Heated water instantly | 18. Foot sensor flush | |
| 09. Seat induction | 19. Mute slow down | |
| 10. Seat heating | 20. Night light | |

V9: Double flip modes Open seat by foot induction
V9YS: Double flip modes Open seat by foot induction Sterilization cleaning

ACC FAULT VOICE REMIND

Test the situation of the toilet,
remind the fault when have any problem

Please deal with

CAUTION



- Automatic open cover
- Foot sensor open seat
- LED digital screen
- Side knob



scan and watch



ZL:2020307402596

PATENTED PRODUCT
NO INFRINGEMENT ALLOWED

V8 (P-trap) V8 (S-trap)

Product Name: Smart Toilet
Dimension: 680x400x470mm
Rough in: 300/400mm
Material: Ceramic/ABS Seat Cover
Heating: Instant

- | | | |
|----------------------------|-------------------------------------|------------------------------|
| 01. Female cleaning | 11. Drying | 21. Leakage protection |
| 02. Hip cleaning | 12. Wind temperature regulation | 22. Energy saving |
| 03. Mobile cleaning | 13. Water temperature regulation | 23. Double filtration |
| 04. Massage cleaning | 14. Water-pressure adjust | 24. 12V safety voltage |
| 05. Self-cleaning nozzle | 15. Automatic flush | 25. Anti-fouling glaze |
| 06. A key to stop | 16. Flush during power failure | 26. Flame retardant material |
| 07. Spray regulation | 17. Flushing by identify male urine | 27. Remote control |
| 08. Heated water instantly | 18. Foot sensor flush | |
| 09. Seat induction | 19. Mute slow down | |
| 10. Seat heating | 20. Night light | |

V8: Double flip modes Open seat by foot induction
V8YS: Double flip modes Open seat by foot induction Sterilization cleaning

UV STERILIZATION LAMP

It is sterilized by ultraviolet radiation
Fungicide rate up to 99.99%, effectively avoid
cross infection



Pseudomonas aeruginosa
Cause skin infection



Escherichia coli
May cause diarrhea



Staphylococcus aureus
Cause respiratory disease



- Automatic open cover
- Foot sensor open seat
- LED digital screen
- Side knob
- Ultraviolet sterilization



scan and watch



ZL : 2020307259742
PATENTED PRODUCT NO
INFRINGEMENT ALLOWED



V7

Basic Version :

- 01.Ultraviolet sterilization
- 02.Manually open the toilet lid
- 03.Feet touch open the lid

High Version :

- 01. Ultraviolet sterilization
- 02. Automatically open the lid
- 03. Feet touch open the lid
- 04. Feet touch the open seat
- 05. Feet touch automatic flush

Top Version :

- 01. Ultraviolet sterilization
- 02. Automatically open the lid
- 03. Feet touch open the lid
- 04. Feet touch the open seat
- 05. Feet touch automatic flush
- 06. Voice control
- 07. Bubble protection

V7 (P-trap) V7 (S-trap)

Product Name: Smart Toilet
Dimension: 680x400x470mm
Rough in: 300/400mm
Material: Ceramic/ABS Seat Cover
Heating: Instant

- | | | |
|----------------------------|-------------------------------------|------------------------------|
| 01. Female cleaning | 11. Drying | 21. Leakage protection |
| 02. Hip cleaning | 12. Wind temperature regulation | 22. Energy saving |
| 03. Mobile cleaning | 13. Water temperature regulation | 23. Double filtration |
| 04. Massage cleaning | 14. Water-pressure adjust | 24. 12V safety voltage |
| 05. Self-cleaning nozzle | 15. Automatic flush | 25. Anti-fouling glaze |
| 06. A key to stop | 16. Flush during power failure | 26. Flame retardant material |
| 07. Spray regulation | 17. Flushing by identify male urine | 27. Remote control |
| 08. Heated water instantly | 18. Foot sensor flush | |
| 09. Seat induction | 19. Mute slow down | |
| 10. Seat heating | 20. Night light | |

Q9 Intelligent Toilet

iDrive system Brand new standard

iDrive™ is the intelligent driving control system, which belongs to the automatic information the latest technology, is now used in Our smart toilet is on.

AI Voice function broadcast

ACC fault diagnosis

Audible care



- LED display
- Dual user mode
- One button knob
- AI Voice broadcast
- Radar detection flip
- Open cover by foot induction

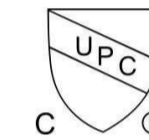

ZL:201830682394.2
PATENTED PRODUCT
NO INFRINGEMENT ALLOWED



gold



silver



scan and watch

Q9 (P-trap) Q9 (S-trap)

Product Name: Smart Toilet
Dimension: 680x400x560mm
Rough in: 300/400mm
Material: Ceramic/ABS Seat Cover
Heating: Instant

- | | | |
|----------------------------|----------------------------------|-------------------------------------|
| 01. Female cleaning | 11. Warm air drying | 21. Power saving |
| 02. Hip cleaning | 12. Wind temperature regulation | 22. Double filtration |
| 03. Mobile cleaning | 13. Water temperature regulation | 23. Power Memory |
| 04. Massage cleaning | 14. Water pressure regulation | 24. 12V safety voltage |
| 05. Self-cleaning nozzle | 15. Auto flush | 25. Anti-fouling glaze |
| 06. One key stop | 16. Power failure flushing | 26. Flame retardant material |
| 07. Self-cleaning of bidet | 17. Mute slow down | 27. Remote control |
| 08. Heated water instantly | 18. Night light | 28. Flushing by identify male urine |
| 09. Seat induction | 19. Instant heating | 29. ACC Automatic fault remind |
| 10. Seat heating | 20. Leakage protection | 30. Two flip modes |

!9: Sunken water tank and no water pressure limit/ No glaze washing

BLOCKED AUTO REBOUND

Innovative design, the cover plate is blocked and automatically rebounded to avoid the pinch injury of the elderly and children.

Flat muteSlow down design, various flap modes, 5 grades adjustment. The thinness of heaven, shaking the worldIts beauty is as new as ever.

- Hindered Springback
- Silent slow down
- Silm and integrated



- LED display
- Dual user mode
- One button knob
- AI Voice broadcast
- Radar detection flip
- Open cover by foot induction



scan and watch



ZL:201830770521.4

PATENTED PRODUCT
NO INFRINGEMENT ALLOWED



gold



sliver

Q10

Product Name:Smart Toilet
Dimension:680x420x570mm
Rough in:300/400mm
Material: Ceramic/ABS Seat Cover
Heating:Instant

- | | | |
|---------------------------|---------------------------------|------------------------------------|
| 01.Female cleaning | 11.Warm air drying | 21.Power saving |
| 02.Hip cleaning | 12.Wind temperature regulation | 22.Double filtration |
| 03.Mobile cleaning | 13.Water temperature regulation | 23.Power Memory |
| 04.Massage cleaning | 14.Water pressure regulaicn | 24.12V safety voltage |
| 05.Sef-cleaning nozzle | 15.Auto flush | 25.Anti-fouling glaze |
| 06.One key slop | 16.Power failune flushing | 26.Flame retardant material |
| 07.Sef cleaning of bidet | 17.Mute slow down | 27.Remole control |
| 08.Heated water instantly | 18.Night light | 28.Flushing by identify male urine |
| 09.Seat induction | 19.Instant heating | 29.ACC Automatic falut remind |
| 10.Seat heating | 20.leakage protection | 30.Two flip modes |

ONE BUTTON KNOB FOR ALL AGES

Convenient for the elderly and children Female cleaning, hip cleaning, flushing functions all in one knob

simple

One button knob
Easy operation

Dazzle

Personalization

Extremely

Times of rotation Up
to 100000 times



ZL:201830770521.4

PATENTED PRODUCT
NO INFRINGEMENT ALLOWED

• Seven colors light
• Double users memory



- LED display
- Dual user mode
- One button knob
- AI Voice broadcast
- Radar detection flip
- Open cover by foot induction



scan and watch

Q8

Product Name: Smart Toilet
Dimension: 670x410x490mm
Rough in: 300/400mm
Material: Ceramic/ABS Seat Cover
Heating: Instant

- | | | |
|----------------------------|----------------------------------|--|
| 01. Female cleaning | 11. Warm air drying | 21. Power saving |
| 02. Hip cleaning | 12. Wind temperature regulation | 22. Double filtration |
| 03. Mobile cleaning | 13. Water temperature regulation | 23. Power Memory |
| 04. Massage cleaning | 14. Water pressure regulation | 24. 12V safety voltage |
| 05. Self-cleaning nozzle | 15. Auto flush | 25. Self-cleaning glaze |
| 06. One key stop | 16. Power failure flushing | 26. Flame retardant material |
| 07. Self-cleaning of bidet | 17. Mute slow down | 27. Remote control |
| 08. Heated water instantly | 18. Night light | 28. Flushing by identify male urine |
| 09. Seat induction | 19. Instant heating | 29. ACC Automatic fault identification |
| 10. Seat heating | 20. Leakage protection | 30. Two flip modes |



- Flush by foot sensor
- Automatic open cover
- LED digital screen

Product Name: Smart Toilet
 Dimension: **33A**(680x400x560mm)
33PS(680x450x560mm)
 Rough in: 300/400mm
 Material: Ceramic/ABS Seat Cover
 Heating: Quickly heating



scan and watch



ZL:2020307766427
 PATENTED PRODUCT
 NO INFRINGEMENT ALLOWED



- AI voice remind
- Automatic open cover
- Open seat by foot sensor
- Flush by foot sensor
- Side knob
- LED digital screen

Product Name: Smart Toilet
 Dimension: **35A**(680x400x560mm)
35BS(680x450x560mm)
 Rough in: 300/400mm
 Material: Ceramic/ABS Seat Cover
 Heating: Quickly heating



scan and watch



ZL:2020306770764
 PATENTED PRODUCT
 NO INFRINGEMENT ALLOWED



33A/33B



33PS



35A/35B



35BS

33A(Flush by foot sensor)

33B(Double flip modes)

33PS(Auto flip+Voice remind+
Foam washing)

01. Female cleaning
02. Hip cleaning
03. Mobile cleaning
04. Massage cleaning
05. Self-cleaning nozzle
06. A key to stop
07. Spray regulation
08. Heated water instantly
09. Seat induction

10. Seat heating
11. Drying
12. Wind temperature regulation
13. Water temperature regulation
14. Water-pressure adjust
15. Glaze washing
16. Automatic flush
17. Flush during power failure
18. Mute slow down

19. Night light
20. Leakage protection
21. Energy saving
22. Double filtration
23. 12V safety voltage
24. Anti-fouling glaze
25. Flame retardant material
26. Remote control

35A(Flush by foot sensor)

35B(Double flip modes)

35BS(Double flip modes)

01. Female cleaning
02. Hip cleaning
03. Mobile cleaning
04. Massage cleaning
05. Self-cleaning nozzle
06. A key to stop
07. Spray regulation
08. Heated water instantly
09. Seat induction

10. Seat heating
11. Drying
12. Wind temperature regulation
13. Water temperature regulation
14. Water-pressure adjust
15. Glaze washing
16. Automatic flush
17. Flush during power failure
18. Mute slow down

19. Night light
20. Leakage protection
21. Energy saving
22. Double filtration
23. 12V safety voltage
24. Anti-fouling glaze
25. Flame retardant material
26. Remote control

Beauty, is more than appearance

Color gives you wonderful changes,extraordinary feelings.Sometimes it's delicate and euphemistic, sometimes it's clank,sometimes it's light and carefree.

■ Red ■ Rose Gold ■ Champagne gold ■ Sliver □ White



LED display
Dual user mode
Foot deductive flushing



scan and watch



ZL:201630518770.5
PATENTED PRODUCT
NO INFRINGEMENT ALLOWED

6800

Product Name:Smart Toilet
Dimension:680x400x530mm
Rough in:300/400mm
Material: Ceramic/ABS Seat Cover
Heating:Instant

- | | | |
|---------------------------|---------------------------------|---------------------------------------|
| 01.Female cleaning | 12.Sensor seat | 23.Leakage proclelor |
| 02.Hip cleaning | 13.Seat heating | 24.Power saving |
| 03.Mobile cleaning | 14.Warm air drying | 25.Double filtration |
| 04.Massage cleaning | 15.Wind temperature regulation | 26.Power Memory |
| 05.Self-cleaning nozzle | 16.Water temperature regulation | 27.12V safely vottage |
| 06.One key to wash | 17.Wall washing | 28.Sell-cleaning gaze |
| 07.Side knob to SPA | 18.Aulo flush | 29.Flame retarcanl materias |
| 08. Cold and hot SPA | 19.Flush during power failure | 30.Renote control |
| 09.One key stop | 20.Instant heating | 31. ACC Automaric faut identification |
| 10.Spray regulation | 21.Mudte slow down | |
| 11.Heated water instantly | 22.Night light | |



LED display
Dual user mode
Foot deductive flushing



scan and watch



ZL:201630518770.5
PATENTED PRODUCT
NO INFRINGEMENT ALLOWED

6600

Product Name:Smart Toilet
Dimension:680x400x530mm
Rough in:300/400mm
Material: Ceramic/ABS Seat Cover
Heating:Instant

- | | | |
|---------------------------|---------------------------------|---------------------------------------|
| 01.Female cleaning | 12.Sensor seat | 23.Leakage proclelor |
| 02.Hip cleaning | 13.Seat heating | 24.Power saving |
| 03.Mobile cleaning | 14.Warm air drying | 25.Double filtration |
| 04.Massage cleaning | 15.Wind temperature regulation | 26.Power Memory |
| 05.Self-cleaning nozzle | 16.Water temperature regulation | 27.12V safely vottage |
| 06.One key to wash | 17.Wall washing | 28.Sell-cleaning gaze |
| 07.Side knob to SPA | 18.Aulo flush | 29.Flame retarcanl materias |
| 08. Cold and hot SPA | 19.Flush during power failure | 30.Renote control |
| 09.One key stop | 20.Instant heating | 31. ACC Automaric faut identification |
| 10.Spray regulation | 21.Mudte slow down | |
| 11.Heated water instantly | 22.Night light | |



ZL:2020307749879
PATENTED PRODUCT
NO INFRINGEMENT ALLOWED

- Flush by foot sensor
- Automatic open cover
- Open seat by foot sensor
- LED digital screen
- Side knob



scan and watch



32A (Flush by foot sensor)
32B (Double flip modes)

Product Name:Mini smart toilet
Dimension:680x400x420mm
Rough in:300/400mm
Material: Ceramic/ABS Seat Cover
Heating:Quickly heating

- | | | |
|---------------------------|---------------------------------|-----------------------------|
| 01.Female cleaning | 10.Seat heating | 19.Night light |
| 02.Hip cleaning | 11.Drying | 20.Leakage protection |
| 03.Mobile cleaning | 12.Wind temperature regulation | 21.Energy saving |
| 04.Massage cleaning | 13.Water temperature regulation | 22.Double filtration |
| 05.Self-cleaning nozzle | 14.Water-pressure adjust | 24.12V safety voltage |
| 06.A key to stop | 15.Glaze washing | 25.Anti-fouling glaze |
| 07.Spray regulation | 16.Automatic flush | 26.Flame retardant material |
| 08.Heated water instantly | 17.Flush during power failure | 27.Remote control |
| 09.Seat induction | 18.Mute slow down | |

32A:Open cover by manual Flush by foot sensor
32BS:Double flip modes Open seat by foot sensor Close cover automatically
Flushing by identify male urine



ZL:202030337831.4
PATENTED PRODUCT
NO INFRINGEMENT ALLOWED

- Open cover by radar automatic
- LED indicating screen
- Knob operation key



scan and watch



Q2

Product Name:Mini smart toilet
Dimension:680x400x560mm
Rough in:300/400mm
Material: Ceramic/ABS Seat Cover
Heating:Instant

- | | | |
|---------------------------|---------------------------------|------------------------------------|
| 01.Female cleaning | 11.Drying from heater | 21.Double filtration |
| 02.Hip cleaning | 12.Wind temperature regulation | 22.Smart cleaning glaze |
| 03.Mobile cleaning | 13.Water temperature regulation | 23.Flame retardant material |
| 04.Massage cleaning | 14.Water-pressure adjust | 24.Power Memory |
| 05.Self-cleaning nozzle | 15.Automatic flush | 25.12V safety voltage |
| 06.A key to stop | 16.Flush during power failure | 26.Remote control |
| 07.Spray regulation | 17.Mute slow down | 27.Flushing by identify male urine |
| 08.Heated water instantly | 18.Night light | 28.Double mode switch |
| 09.Seat induction | 19.Leakage protection | |
| 10.Seat heating | 20.Energy province electricity | |



ZL:202030081731.X
PATENTED PRODUCT
NO INFRINGEMENT ALLOWED

- No water pressure limit
- Open cover by radar automatic
- LED indicating screen
- Knob operation key



scan and watch



i3 Foot flush can be customized

Product Name:Mini smart toilet
Dimension:680x400x560mm
Rough in:300/400mm
Material: Ceramic/ABS Seat Cover
Heating:Instant

- | | | |
|---------------------------|---------------------------------|------------------------------------|
| 01.Female cleaning | 11.Drying from heater | 21.Double filtration |
| 02.Hip cleaning | 12.Wind temperature regulation | 22.Smart cleaning glaze |
| 03.Mobile cleaning | 13.Water temperature regulation | 23.Flame retardant material |
| 04.Massage cleaning | 14.Water-pressure adjust | 24.Power Memory |
| 05.Self-cleaning nozzle | 15.Automatic flush | 25.12V safety voltage |
| 06.A key to stop | 16.Flush during power failure | 26.Remote control |
| 07.Spray regulation | 17.Mute slow down | 27.Flushing by identify male urine |
| 08.Heated water instantly | 18.Night light | 28.Double mode switch |
| 09.Seat induction | 19.Leakage protection | |
| 10.Seat heating | 20.Energy province electricity | |



ZL:202030337870.4
PATENTED PRODUCT
NO INFRINGEMENT ALLOWED

- No water pressure limit
- Open cover by radar automatic
- LED indicating screen
- Knob operation key



scan and watch



i5 Foot flush can be customized

Product Name:Mini smart toilet
Dimension:680x400x560mm
Rough in:300/400mm
Material: Ceramic/ABS Seat Cover
Heating:Instant

- | | | |
|---------------------------|---------------------------------|------------------------------------|
| 01.Female cleaning | 11.Drying from heater | 21.Double filtration |
| 02.Hip cleaning | 12.Wind temperature regulation | 22.Smart cleaning glaze |
| 03.Mobile cleaning | 13.Water temperature regulation | 23.Flame retardant material |
| 04.Massage cleaning | 14.Water-pressure adjust | 24.Power Memory |
| 05.Self-cleaning nozzle | 15.Automatic flush | 25.12V safety voltage |
| 06.A key to stop | 16.Flush during power failure | 26.Remote control |
| 07.Spray regulation | 17.Mute slow down | 27.Flushing by identify male urine |
| 08.Heated water instantly | 18.Night light | 28.Double mode switch |
| 09.Seat induction | 19.Leakage protection | |
| 10.Seat heating | 20.Energy province electricity | |



ZL:202030337869.1
 PATENTED PRODUCT
 NO INFRINGEMENT ALLOWED

- No water pressure limit
- Open cover by radar automatic
- LED indicating screen
- Knob operation key



scan and watch



ZL : 202130803229. X
 Patented product
 no infringement allowed

- ONE KEY KNOB
- SIDE HANDLE
- LED Indicator Light

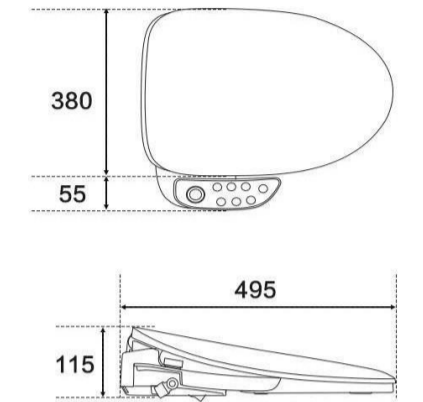

i7 Foot flush can be customized

Product Name:Mini smart toilet
 Dimension:680x400x560mm
 Rough in:300/400mm
 Material: Ceramic/ABS Seat Cover
 Heating:Instant

- | | | |
|---------------------------|---------------------------------|------------------------------------|
| 01.Female cleaning | 11.Drying from heater | 21.Double filtration |
| 02.Hip cleaning | 12.Wind temperature regulation | 22.Smart cleaning glaze |
| 03.Mobile cleaning | 13.Water temperature regulation | 23.Flame retardant material |
| 04.Massage cleaning | 14.Water-pressure adjust | 24.Power Memory |
| 05.Self-cleaning nozzle | 15.Automatic flush | 25.12V safety voltage |
| 06.A key to stop | 16.Flush during power failure | 26.Remote control |
| 07.Spray regulation | 17.Mute slow down | 27.Flushing by identify male urine |
| 08.Heated water instantly | 18.Night light | 28.Double mode switch |
| 09.Seat induction | 19.Leakage protection | |
| 10.Seat heating | 20.Energy province electricity | |

T1

Product Name:Smart Toilet Cover
 Dimension:495x435x115mm
 Material:ABS Bidet Seat
 Heating Type:Instant Heating

- | | | |
|-------------------------|-----------------------------|--------------------------------|
| 01.Female Washing | 08.Heated Water Instantly | 15.Mute Slow Down |
| 02.Hip Cleaning | 09.Seat Induction | 16.Night Light |
| 03.Mobile Washing | 10.Seat Heating | 17.Leakage Protection |
| 04.Message Washing | 11.Warm Air Drying | 18.Energy Province Electricity |
| 05.Self-cleaning Nozzle | 12.Wind Temperature Adjust | 19.Double Filtration |
| 06.A Key To Stop | 13.Water Temperature Adjust | 20.Electricity power memory |
| 07.Nozzle Adjustment | 14.Water Pressure Adjust | 21.12V safety voltage |



ZL:202030290242.5
 PATENTED PRODUCT
 NO INFRINGEMENT ALLOWED

- No water pressure limit
- Open cover by radar automatic
- LED indicating screen
- Knob operation key



scan and watch



i8 Foot flush can be customized

Product Name:Mini smart toilet
 Dimension:680x400x560mm
 Rough in:300/400mm
 Material: Ceramic/ABS Seat Cover
 Heating:Instant

- | | | |
|---------------------------|---------------------------------|------------------------------------|
| 01.Female cleaning | 11.Drying from heater | 21.Double filtration |
| 02.Hip cleaning | 12.Wind temperature regulation | 22.Smart cleaning glaze |
| 03.Mobile cleaning | 13.Water temperature regulation | 23.Flame retardant material |
| 04.Massage cleaning | 14.Water-pressure adjust | 24.Power Memory |
| 05.Self-cleaning nozzle | 15.Automatic flush | 25.12V safety voltage |
| 06.A key to stop | 16.Flush during power failure | 26.Remote control |
| 07.Spray regulation | 17.Mute slow down | 27.Flushing by identify male urine |
| 08.Heated water instantly | 18.Night light | 28.Double mode switch |
| 09.Seat induction | 19.Leakage protection | |
| 10.Seat heating | 20.Energy province electricity | |